

READ & SAVE THESE INSTRUCTIONS.

This manual contains operating information and should be left with the unit.

Vapac®

Model VS--D

Steam Room Unit

Installation & Operating Manual

Edition 1.3.1

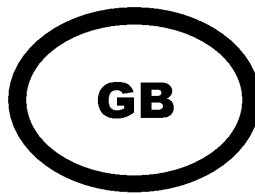

Installation in countries covered by EC Directives:

This product meets the requirements of the RoHS Directive 2002/95/EEC

This product will meet the requirements of the Low Voltage Safety Directive 2006/95/EEC and the EMC Directive 2004/108/EEC when installed in accordance with the instructions contained in this manual.

Failure to comply with these instructions may invalidate the manufacturer's warranty or any certificate/declaration of conformance requested to be supplied with the unit.



Table of Contents

Important Installation Points.....	4
Important Electrical Connection Items.....	4
Important Maintenance Items.....	4
1.0 Installation.....	5
1.1 Vapac LE unit dimensions.....	6
1.2 LExx-SR weights.....	8
1.3 Positioning the steam pipes.....	8
2.0 Plumbing Considerations.....	10
2.1 Cold water supply.....	10
2.2 Drain connection.....	10
3.0 Electrical Connections.....	11
3.1 Power Supply Connection.....	11
3.2 Control Connections.....	11
4.0 Controls.....	13
5.0 Status Indications.....	14
5.1 Normal Run / Standby / Start-up – No User Intervention Required.....	15
5.2 Fault / Service Indications – Requiring Operator Intervention.....	16
5.3 Resetting the fault condition.....	16
6.0 Cylinder Exchange.....	17
6.1 Procedure for Cylinder Exchange.....	17
6.2 Service and Maintenance.....	18
6.2.1 Feed Valve with Strainer.....	18
6.2.2 Drain Pump.....	19
7.0 Electrical Data.....	20
8.0 Circuit Diagram.....	21
9.0 Trouble-shooting Check List.....	22

Important Installation Points

The unit must be installed to comply with national regulations and/or codes of practice. A qualified electrician must carry this out.

Ensure at least 1000 mm clear front access to the electrical and steam sections.

Do not locate the cabinet where the ambient temperature around the unit could exceed 35° C; or fall below 5° C e.g., an unventilated roof mounted enclosure – see minimum space / ventilation requirements page 7. * If below 5° C Frost protection kit required.

Do not locate the cabinet where a ladder is required for service access as this could make servicing and cylinder service or exchange hazardous.

Make sure steam line(s) have adequate slope (min 12%) for condensate drainage and use condensate separators if the pipe is lower than the unit.

Provide adequate support to prevent sags developing in flexible steam lines, which can fill with water and create a "trap".

Do not locate vented drain directly under the cabinet.

Important Electrical Connection Items

Before commissioning the unit, check that all electrical (power) connections - including those at the terminals and contactor are tight.

The Vapac transformer must not be used to power other equipment.

To comply with EMC aspects see recommendations on page 10.

Do not mount the unit close to a source of strong electromagnetic emissions, such as a variable speed motor drive, Kva transformer, or 'UPS' unit.

A minimum gap of 2 meters must be maintained between the unit and such devices.

Larger output devices may require an increased gap distance, depending on the nature of screening / filtration measures fitted to the device.

Important Maintenance Items

Only a qualified electrician should carry out maintenance.

The boiler contains hot water, and must be drained before any maintenance is carried out on the steam section. This should be done prior to isolating the power, and removing the front access panel

ESD SENSITIVE DEVICES USED ON PCB. ENSURE ANTI-STATIC PRECAUTIONS ARE TAKEN WHEN REMOVING OR REPLACING PCB'S.

1.0 Installation

Do's

- Do** mount the unit as close to the steam distribution pipe(s) as possible.
- Do** mount the unit at a height convenient for reading the display window.
- Do** ensure adequate side ventilation (min 80 mm).
- Do** ensure adequate service access to the front of the unit (min 1000 mm).
- Do** ensure adequate service access below the unit (min 1000 mm).
- Do** ensure that the holes in the rear top panel remain unobstructed to allow a free flow of air.
- Do** use the marking on the side of the carton as a template to mark the mounting hole positions.
- Do** remove the cylinder, if necessary, to access the mounting holes in the back of the steam section.
- Do** use M6 projecting type wall bolts or equivalent to mount the unit in position.

Don'ts

- Don't** mount the unit close to sources of strong electro-magnetic emissions e.g. variable speed lift motor drives, kVa transformers etc.
- Don't** mount the unit in an unventilated enclosure.
- Don't** mount in a position requiring ladder access to the unit.
- Don't** mount the unit behind a false ceiling or other situation where an unusual malfunction (e.g. water leak) would cause damage.
- Don't** mount the unit in an area which will be hosed down.
- Don't** install the unit where the ambient temperature can exceed 35°C; or fall below 5°C.
- Don't** mount the unit inside a cold-room or other place where temperature and humidity conditions can cause condensation on electrical components.
- Don't** mount the unit where the sound of a contactor opening/closing and water flow in a pipe would be unacceptable e.g. libraries, private apartments, etc

1.1 Vapac LE unit dimensions

Cabinet Sz 1 (5 – 18 kg/h Models)

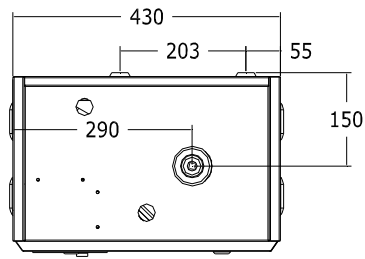

Left:

Top View Showing Steam O/let position and wall mounting points.

Below: Side View showing wall mounting points.

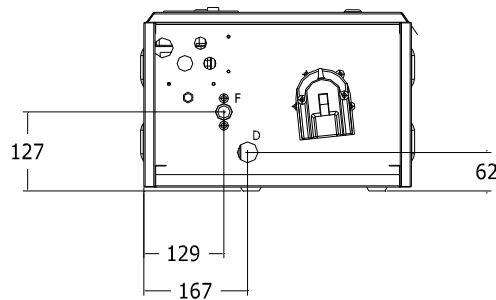
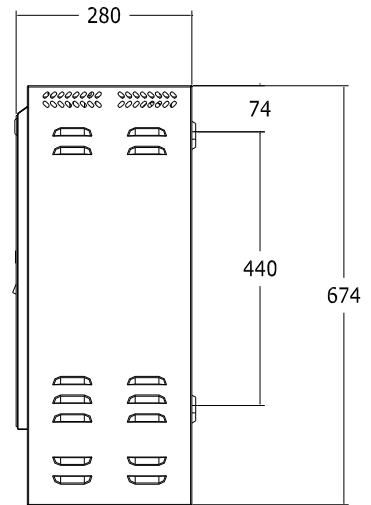
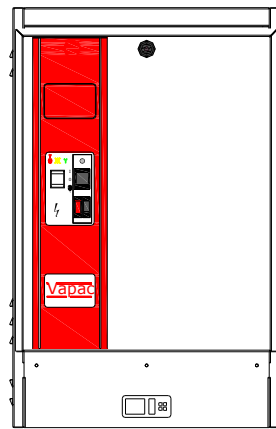
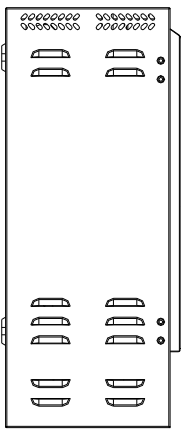

Left:

Bottom View Showing

"F" (Feed connection) 3/4" BSP male connection for flexible hose provided with unit.

"D" (Drain connection)

35 mm pipe.

Cabinet Sz 2 (30 – 55 kg/h Models)

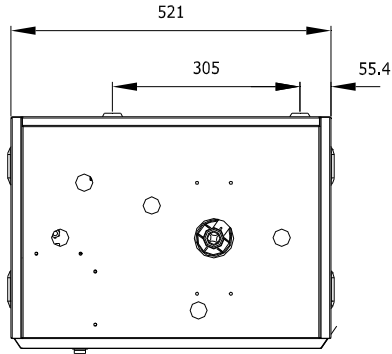

Left:

Top View Showing Steam O/let position and wall mounting points.

Below: Side View showing wall mounting points.

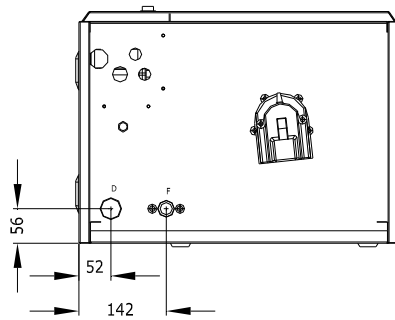
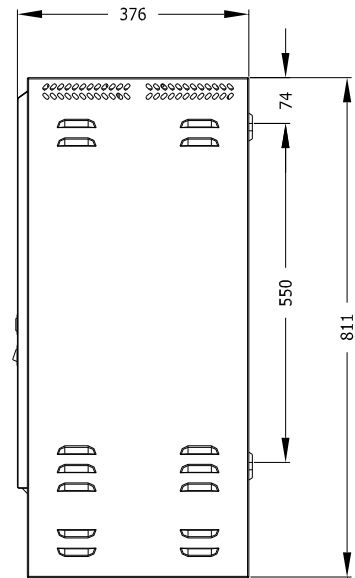
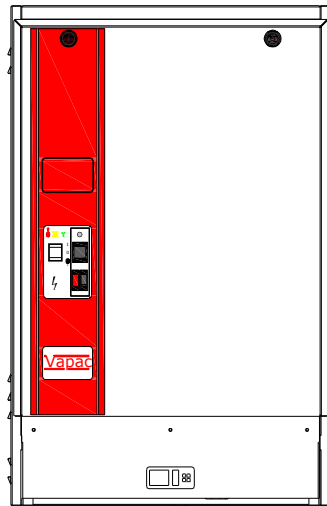
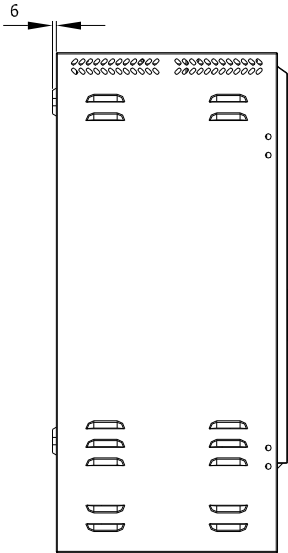

Left:

Bottom View Showing

“F” (Feed connection) 3/4” BSP male connection for flexible hose provided with unit.

“D” (Drain connection)

35 mm pipe.

1.2 LExx-SR weights

The unit dry weight is the delivered unit with no water in the unit, the wet weight is the operational weight when the unit is running.

Vapac model	Dry Kg	Wet Kg
LE18-SR	39	65.5
LE30-SR	40	66.5
LE45-SR / LE55-SR	45	72

1.3 Positioning the steam pipes

Do's

Do use Vapac steam hose or well insulated copper pipe

Do keep steam hose as short as possible (under 2m for max efficiency).

Do arrange to have a vertical rise immediately over the unit of 300mm

Do inject the essence into the steam line below the level of the cylinder and ensure that it can flow freely out with the flow of steam. Any restrictions in flow will result in the essence solidifying and causing a restriction to flow of steam.

Do add extra insulation to steam hose for longer runs (2m-5m) and in cold ambient conditions to avoid excess condensate and reduction in delivered output.

Don'ts

Don't allow steam hose to develop kinks or sags.

Don't include horizontal runs or 90° elbows in the steam line.

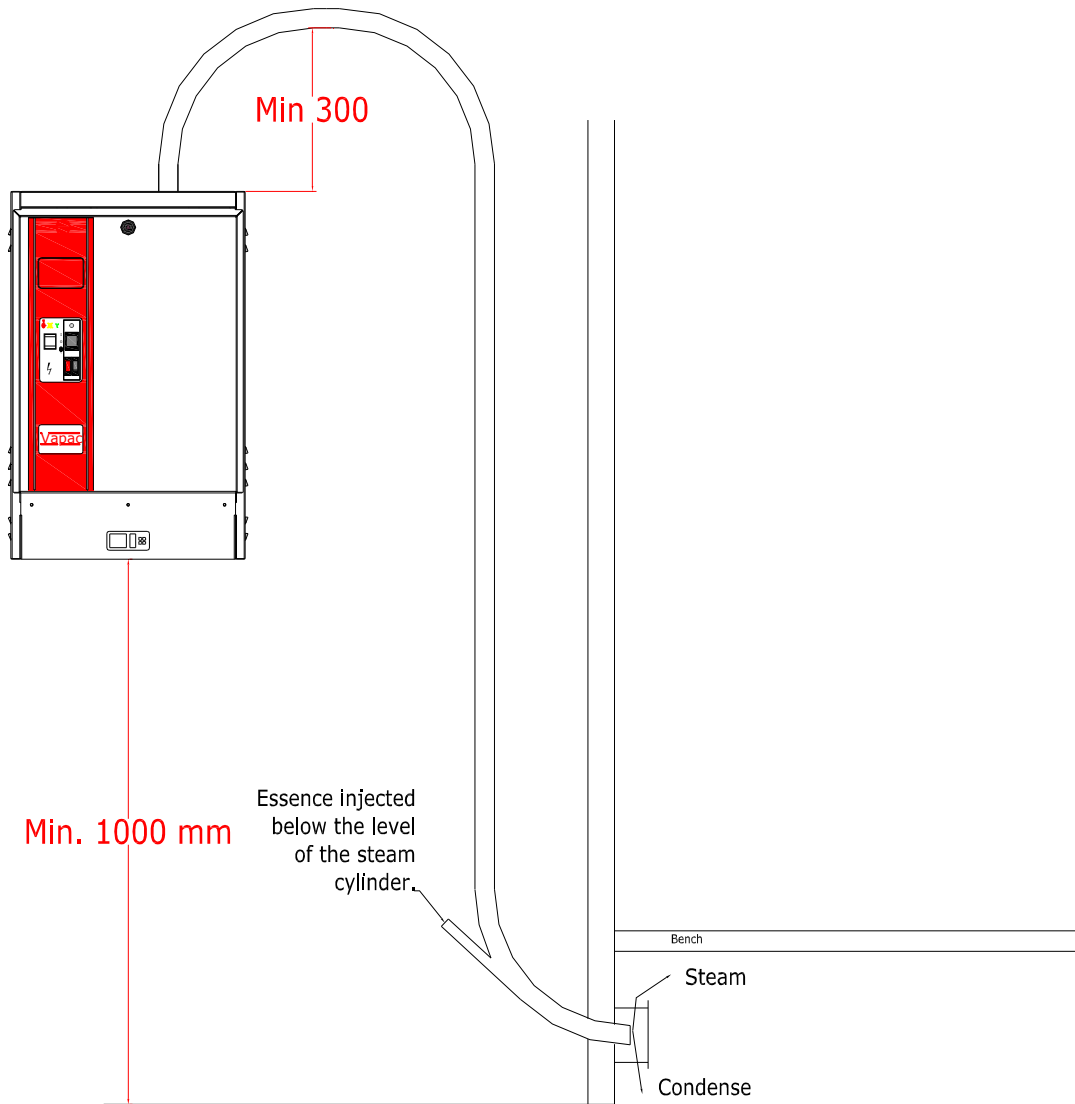

2.0 Plumbing Considerations.

2.1 Cold water supply.

General

The Electro Boiler range of units is capable of operating with mains water supplies within the following limits:-

Hardness	50 –500 ppm
Conductivity	80 – 1000 µS/cm
Silica	0
Pressure of between 1 - 8 bar.	

Water Supply rates	
1.2 l/min	<= LE18-SR
2.4 l/min	>= LE30-SR

Do's

Do install a stop-valve/isolating valve and a strainer close to the unit.

Do provide a water supply with sufficient pressure and pipe size to ensure an adequate flow rate to all units connected to the system.

Do use the water connection with nylon nut provided.

Don'ts

Don't use a wrench or other tool to tighten the water supply connection - the nylon nut and rubber washer provided, should only require tightening by hand to effect a seal. If water seepage occurs, undo the nut to wipe the washer clean and re-seat it.

2.2 Drain connection.

General

Do's

Do ensure metal drain and supply water pipework is grounded electrically close to the unit (a ground/earth stud is positioned on the underside of the cabinet

Drain capacity per cylinder = pump discharge rate of max 16.8 l/min at 50 Hz (17.2 l/min at 60 Hz).

Drain Connection

Do's

Do use copper or plastic pipe rated for 100 °C.

Do arrange to discharge drain water from the unit into a trapped and vented drain at a position where flash steam rising from the drain line vent will not pose a problem for the VAPAC or other equipment.

Do provide adequate fall for the drain pipework to allow free flow of water drained from each unit.

Do ensure drain line pipe size will accommodate water being drained at the same time from all the VAPAC units that are connected to it.

3.0 Electrical Connections

3.1 Power Supply Connection

The wiring to the Vapac should be carried out by a qualified electrician. The external over-current protection and wiring should comply with the appropriate Regulations and Codes of Practice.

IMPORTANT: A fused disconnect/isolator or MCB should be fitted so as to disconnect the supply from all electrodes simultaneously. This must be sized to suit the total maximum phase/line current of the unit and should be located adjacent to the unit and be within easy reach and readily accessible.

The units can be connected for single or 3 phase operation and should be connected as shown below:

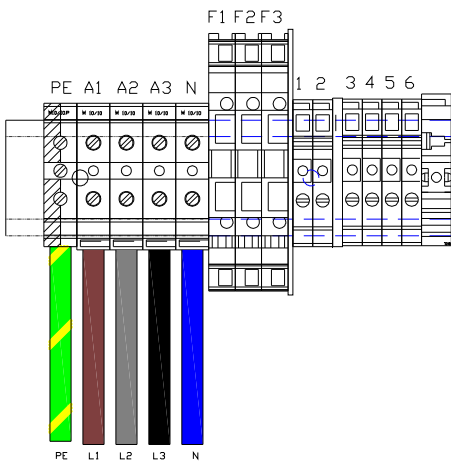

Three Phase connection:

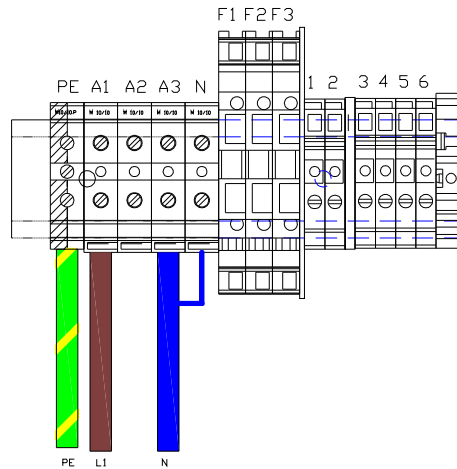

Single Phase connection

3.2 Control Connections

The unit is supplied with all the required control connections made – all that is required is that the temperature sensor that is pre-wired into the controller needs to be run such that it senses the temperature inside the steam room.

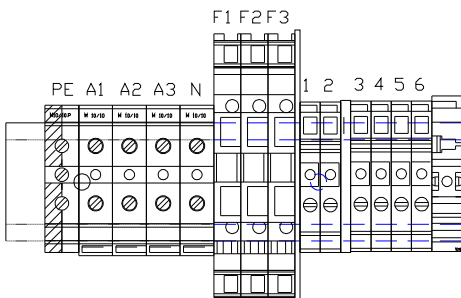

Additionally terminals 1 + 2 provide a fused, switched 230 V Phase & Neutral supply to power an essence pump.

4.0 Controls

The position of the relevant controls are reproduced below.

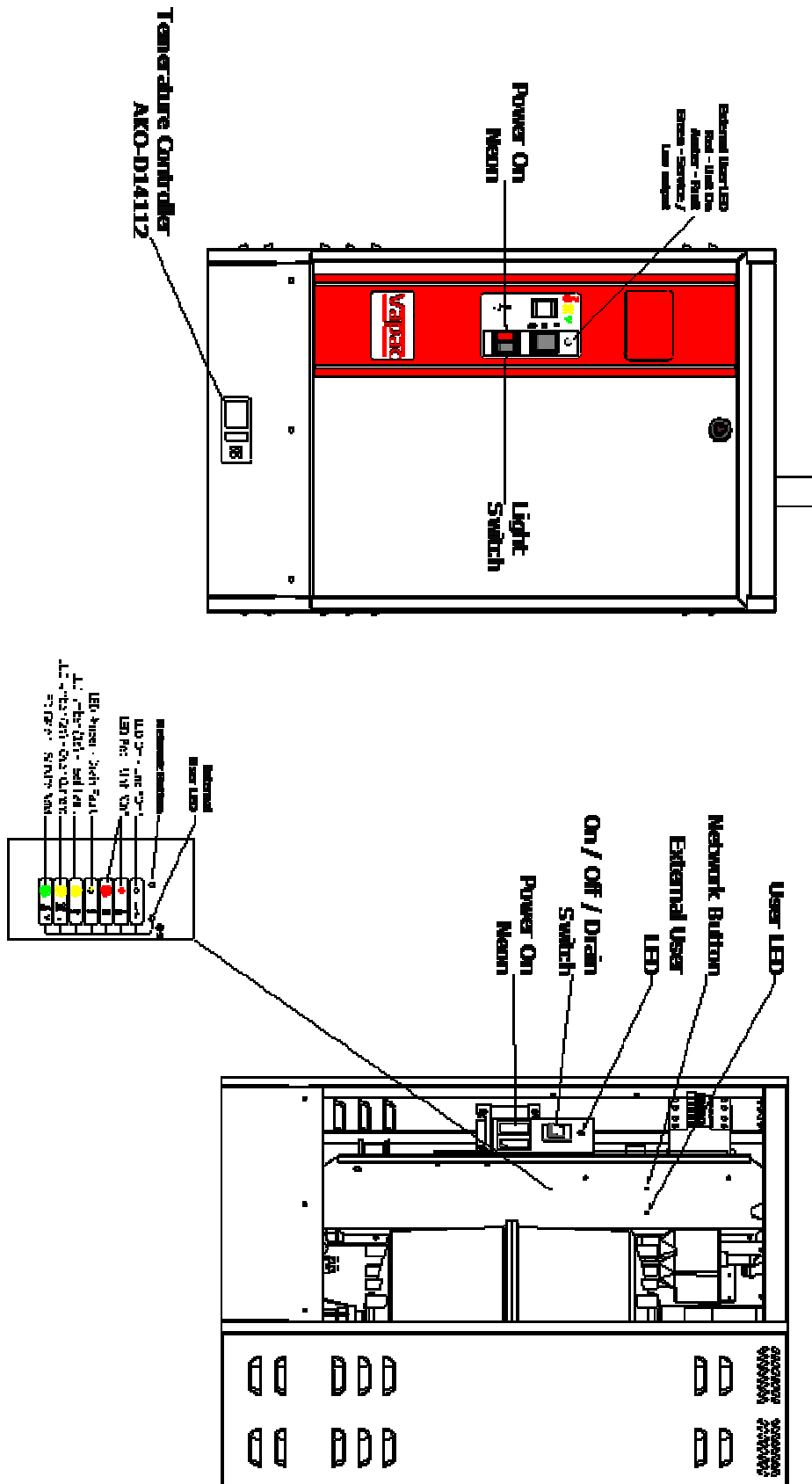

5.0 Status Indications

User LEDs

User LED State		Description
1	RED Flashing 2 second period	Unit initialising. IF REMAINS IN THIS STATE, THEN UNIT DOES NOT HAVE A VALID UCP1 FITTED.

Prior to the start of the initialisation process, the LEDs will flash Green, Red, Amber repeatedly for 10 seconds to check that the LEDs are operating correctly.

Remedy:

- 1 Check that UCP1 is fitted to plug fitted to CR4 pins 7 & 8.

5.1 Normal Run / Standby / Start-up – No User Intervention Required

User LEDs being off, RED or RED Flashing refer to following table.

User LEDs		Description
1	OFF	Unit in shutdown.
2	OFF	Unit in standby
3	Green Amber Flashing Variable	Unit in Startup.
	RED Flashing Variable Period or ON	Unit Online.

The above are purely indications of the current state of the unit and require no action from the operator.

When the state changes, the indication will automatically change.

5.2 Fault / Service Indications – Requiring Operator Intervention.

User LED 1 State		Description
1	AMBER	Drain Fault
2	AMBER Flashing 1 second period	Feed Fault
3	AMBER Flashing 2 second period	Over current Fault
4	AMBER/OFF/AMBER/OFF /GREEN/OFF	No Voltage input
5	Green	Service Now

1, 2 & 3 **Fault stop:** Once the problem has been cleared the fault can be re-set by following the procedure listed at point 5.3 below.

4 **No voltage input:** Check the wiring to CR6 and CR7 of the “level sense” daughter board (part number 1150633-3). If the line voltage can be measured here, check the wiring between CR1 pins 5 & 6, of the same daughter board and CR2 pins 1 & 3 of the main control PCB. If this is also correct then either the daughter board or the main control PCB is faulty. Once the fault has been cleared the LED indications will revert back to the cylinders “current state”.

5 Service the unit, by following the instructions on pages 15 & 16.

5.3 Resetting the fault condition.

Once the fault has been rectified the unit may be re-started by powering the unit down (at the main isolator) waiting ten seconds and re-applying power.

6.0 Cylinder Exchange

Cylinder Life

The water hardness and the humidity demand at site will determine the effective life of a steam cylinder. Units located in areas with naturally soft waters will experience the longer cylinder life, possibly upwards of 12 months in calendar terms. With hard waters, a more frequent cylinder exchange must be expected and cylinder exchange 2 or 3 times a year can be the average situation. The normal scaling up of the Vapac steam cylinder is outside the VAPAC warranty.

6.1 Procedure for Cylinder Exchange

1. With power connected to the unit operate the Manual Drain switch and empty the steam cylinder.
2. Disconnect the VAPAC from the incoming electrical supply by means of the external disconnect switch.
3. Remove the lockable door to the cylinder chamber and carefully ease off the electrode caps.
4. Loosen the hose clip and disconnect the steam hose from the top of the steam cylinder.
5. Using a twisting movement, lift the cylinder clear of its seating in the feed/drain manifold and carefully remove the used cylinder from the unit.
6. Inspect the feed/drain manifold to ensure this is clear of sediment.
7. The drain pump can be removed for inspection/cleaning. By following the instructions for the drain pump removal and cleaning below.
8. With the pump back in position after cleaning, insert the cylinder into the feed / drain manifold, pushing it down firmly, and reconnect the steam hose.
9. The electrode caps must be reconnected in the same sequence in accordance with the details on the collar supplied with the new cylinder.
10. The VAPAC unit is supplied with electrode cables routed to avoid contact with the removable door. After a cylinder exchange, it is important to replace the cables as close as possible to their original route.

Vapac Cleanable cylinders

Cleanable versions of the Vapac cylinders are available which can be opened to allow removal of loose scale deposit. The cylinder designs are the same but instead of a welded join, the two parts are brought together by a seal and two clamping rings with quick-release fasteners.

To order the equivalent cleanable cylinder use the same code but substitute the letters **CC** instead of **CM** or **CD**.

When servicing a cleanable cylinder take it to a service area where it is convenient to open it and to dispose of the contents. When cleaning out loose material also remove any build-up on the end of the short "cylinder full" electrode. Make sure the slotted strainer is clean, intact and in place. When re-

assembling, use a new seal and make sure mating surfaces are free of scale particles as they will prevent a perfect seal and cause leaks.

Note 1: Do not touch an operating cylinder of this type in case there is a leak allowing water at mains voltage to seep out.

Note 2: Do not interfere with the electrodes, if they are badly eroded and/or the internal positioning ring is free, a new cylinder should be used.

6.2 Service and Maintenance

As the operation of the Vapac is entirely automatic, it normally requires no attention on a day-to-day basis. General cleaning and maintenance of the component parts of the Vapac are recommended at intervals of about one year, but this is largely dependent upon the frequency of its use and the quality of the water supply. Where the Vapac is part of an air-conditioning system being serviced regularly, the Vapac should be inspected at the same time.

6.2.1 Feed Valve with Strainer

The nylon bodied solenoid valve incorporates a small nylon strainer which is a push fit in the 3/4" inlet of the valve. With a new plumbing installation, residual loose solid material in the pipework could partially block the strainer after start-up. If for this or any other reason a restriction of the water flow is suspected (outside of supply pressure considerations), it would be possible to clean the strainer as follows:-

Turn off the water supply to the Unit.

Undo the nylon nut connecting the flexible connection to the valve inlet.

The strainer can be removed using 'long-nosed' pliers to grip the center flange provided on the strainer for this purpose.

Withdraw the strainer.

Wash and replace it.

Reconnect and turn on water supply.

Reconnect electrical supply to allow unit to operate.

Valve with flow restrictor

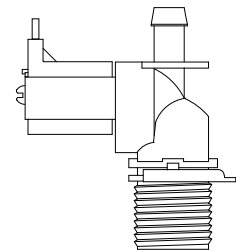

Strainer

3/4 Nylon nut with washer as part of flexible connector

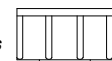

Note: Always replace the strainer after cleaning as it is required to prevent material lodging in the valve seat or blocking the small flow control restrictor which is fitted in the valve.

6.2.2 Drain Pump

The pump is a sealed unit and should not be dismantled. Instructions for removal / replacement are as follows.

1) Place a bucket below the pump, to catch any water remaining in the housing or pipework.

2) Remove the two screws holding the pump cover & lift clear.

3) Undo the three screws holding the pump body to the feed & drain manifold, and remove it - any water trapped in the pump will be released at this point.

4) Fit the replacement pump by following the above steps in reverse order. Ensuring that the O-ring surrounding the impeller housing is correctly seated, and that it mates correctly with the feed / drain manifold.

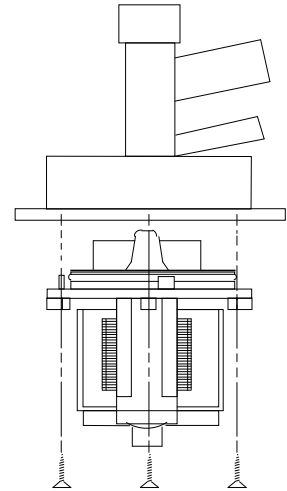

7.0 Electrical Data

Model Ref.		LE18-SR					LE30-SR			LE45-SR			LE55-SR		
Nominal Output	Kg/hr	5	9	18	18	18	30	30	30	45	45	45	55	55	55
Voltage	V	230	230	380	400	415	380	400	415	380	400	415	380	400	415
Power input rating	Kw	3.72	6.68	13.48	13.53	13.35	22.25	22.43	22.25	33.85	33.65	33.54	41.37	40.91	41.07
Electrical Supply	Ph's	Ph+N	Ph+N	3Ph	3Ph	3Ph	3Ph	3Ph	3Ph	3Ph	3Ph	3Ph	3Ph	3Ph	3Ph
No. of electrodes		2	2	3	3	3	3	3	3	6	6	6	6	6	6
Full load Current	A	17	30.5	21.5	20.5	19.5	35.5	34	32.5	54	51	49	66	62	60
Maximum overcurrent	A	25.5	45.75	23.65	22.55	21.45	39.05	37.4	35.75	59.4	56.1	53.9	72.6	68.2	66
CSP setting	A	17	30.5	21.5	20.5	19.5	35.5	34	32.5	27	25.5	24.5	33	31	30
Fuse Rating/phase	A	32	50	32	32	25	50	50	40	63	63	63	80	80	80
Supply cable terminals	mm ²	10	16	16	16	16	16	16	16	35	35	35	35	35	35
Wiring diagram	A3LZD608														
Cabinet size	Size 1						Size 2								

8.0 Circuit Diagram

RevNo	Revision note	Date	Signature	Checked
-------	---------------	------	-----------	---------

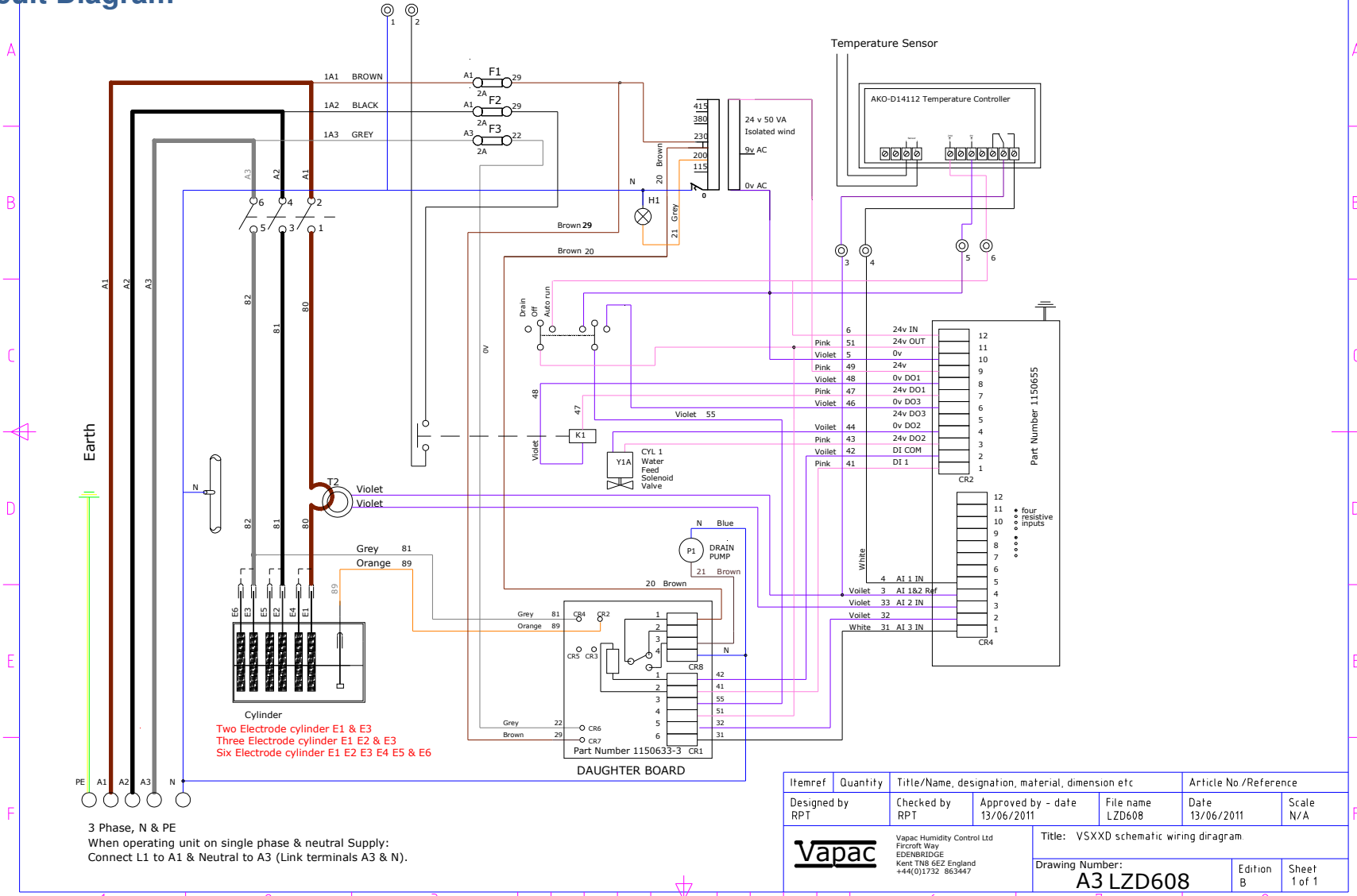

Itemref	Quantity	Title/Name, designation, material, dimension etc		Article No./Reference	
Designed by RPT	Checked by RPT	Approved by - date 13/06/2011	File name LZD608	Date 13/06/2011	Scale N/A
			Title: VSXXD schematic wiring diagram. Drawing Number: A3 LZD608 Edition: B Sheet: 1 of 1		

9.0 Trouble-shooting Check List

Preliminary - Use manual drain option to check pump operation

Symptom **Check/Cause/Remedy**

Power-On Neon – Off - Check main power is connected and switched on.
 Symbol-LED – Off - Check power supply fuses.

Power-On Neon – On - Check if security circuit is open circuit
 Symbol-LED – On - Check 24V 3.15A fuse mounted on the Vapanet controller PCB 1150655

Automatic STOP – Feed Fault indicated.

Possibilities

Water is not connected

Checks

- Check water stop valve is open.

Water connected but not reaching cylinder

- Check internal Vapac hose connections for a leak.

Automatic Stop – Drain Fault indicated.

Possibilities

Drain pump function impaired

Checks

- If pump will not function, empty cylinder by disconnecting the water supply hose between the tundish and the cylinder (at the tundish fill-cup) and lowering it to drain the water into a bucket. Remove, dismantle and clean pump.
 - Check un-block drain hoses

Unit On-Line but inadequate or no steam production.

Possibilities

Contactors not made

Checks

- Contactor coil, Control PCB.

Cylinder scaled up.

- Cylinder Inspection (replace if necessary).



Made in England by:

0410272

Vapac Humidity Control Ltd.

18th February 2015

Vapac Humidity Control Ltd. reserve the right to change the design or specification of the equipment described in this manual without prior notice.